

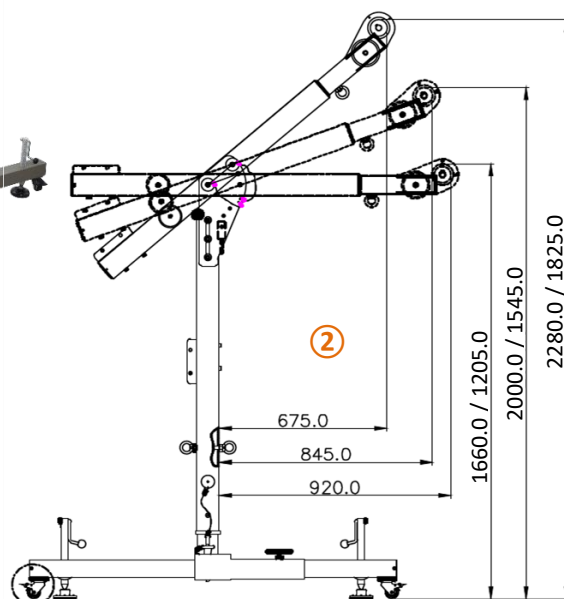

FA 60 105 00, FA 60 105 07

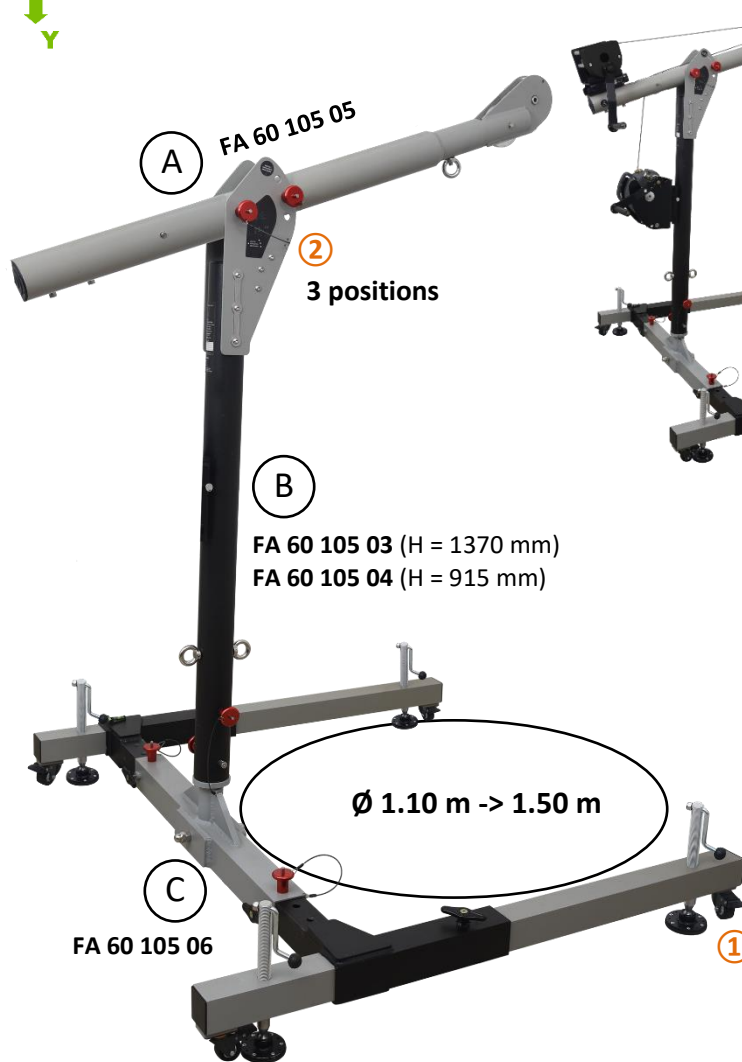





EASY SAFEWAY 1



FA 60 105 00 =	FA 60 105 07 =
FA 60 105 03	FA 60 105 04
+ FA 60 105 05	+ FA 60 105 05
+ FA 60 105 06	+ FA 60 105 06

HS CODE
76169990
CARTON SIZE / PCS.
(A) FA 60 105 05 : 157 x 25 x 20 cm / 1 pc. (B) FA 60 105 03 : 157 x 25 x 20 cm / 1 pc. OR (B) FA 60 105 04 : 120 x 25 x 20 cm / 1 pc. (C) FA 60 105 06 : 144 x 67 x 40 cm / 1 pc.
AET (UE) N°2777/16442-01/E01-01
Satra Technology Europe Ltd., N° 2777, Bracetown Business Park, Clonee, Dublin, D15YN2P, Ireland
MODULE D FI14/14003.01
SGS Fimko Oy, N°0598 Takomotie 8, 00380 HELSINKI, Finland
AET (UKCA) N°AB0321/15998-01/E01-01
Satra Technology Centre, N°0321 Wyndham Way, Telford Way, Kettering Northamptonshire, NN16 8SD, United Kingdom
MODULE D 11 IN14/14003
SGS United Kingdom Ltd., N°0120 Unit 202B, Worle Parkway, Weston-super-Mare, BS22 6WA, United Kingdom

REF.	FA 60 105 00 FA 60 105 07	
CE	EN 795:2012 Type B	
	x1	
	500 KG	
MAT.		
DIM. \updownarrow H	3 positions : 1.66 m / 2.00 m / 2.28 m 1.20 m / 1.54 m / 1.82 m	
R (kN) / MBS (kN)	12 kN / 21 kN	
	Min. 1,10 m / Max. 1,50 m	
+	(1) Machinery Directive + EN 1808 (2) FA 60 022 01/02/11/12/13 (2) FA 60 105 01 + FA 20 401 XX/FA 20 401 XXS (3) FA 60 105 02 + FA 60 003 XX/FA 60 003 XXS/FA 60 023 20/FA 60 023 20R	
	62 KG A 11 KG + B 16 KG + C 35 KG	58,35 KG A 11 KG + B 12.35 KG + C 35 KG



Nombre d'utilisateurs
Number of users
Cantidad de usuarios
Quantità di utilizzatori
Anzahl der Benutzer

R (kN) / MBS (kN)

Résistance statique (en kN) / Résistance à la rupture
Static strength / Minimum Breaking Strength
Resistencia estática (en kN) / Resistencia a la ruptura (en kN)
Resistenza statica (in kN) / Resistenza alla rottura (in kN)
Statische Festigkeit (in kN) / Bruchfestigkeit (in kN)



Charge maxi admissible
Max. allowable load
Carga máxima admisible
Peso massimale
Zulässige Höchstlast

DIM. \updownarrow H

Hauteur
Height
Altura
Altezza
Höhe

+ (1)

Point fort
Key feature
Ventaja principal
Punti forti
Produktvorteil



Empattement base en H
H-shaped wheelbase
Distancia entre ejes de base en H
Ingombro base a H
Standbreite Basis in H

+ (2)

À utiliser avec
To be used with
Para usar con
Ad essere utilizzato con
Verwendet werden soll mit